



SKYWORKS®

DATA SHEET

SKY65724-11: Low-Noise Amplifier Front-End Module with Pre-Filter for BDS/GPS/GNSS Applications

Applications

- BDS/GPS/GNSS radio receivers
- Global Navigation Satellite Systems (GLONASS)
- Fitness/activity trackers
- Smartphones
- Laptop PCs and tablets

Features

- Small signal gain: 16 dB typical
- Low noise figure: 1.8 dB typical
- Excellent out-of-band rejection
- Low current consumption
- Input/output impedance internally matched to 50 Ω
- Single DC supply: 1.62 to 3.6 V
- Minimal number of external components required
- Small MCM 8-pin, 1.1 x 1.5 mm package (MSL3, 260°C per JEDEC J-STD-020)



Skyworks Green™ products are compliant with all applicable legislation and are halogen-free. For additional information, refer to *Skyworks Definition of Green™*, document number SQ04-0074.

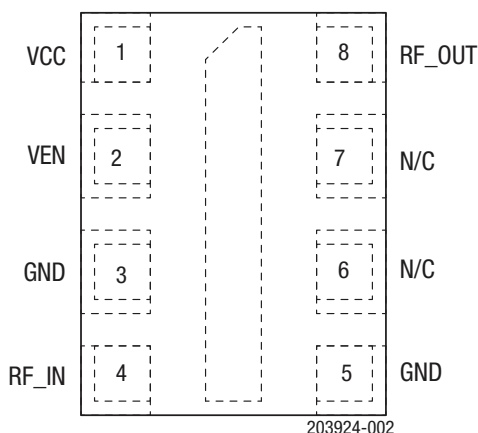

Figure 1. SKY65724-11 Pinout (Top View)

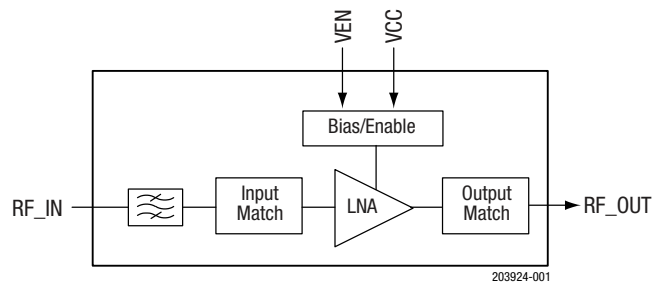

Figure 2. SKY65724-11 Block Diagram

Description

The SKY65724-11 is a front-end module (FEM) with an integrated low-noise amplifier (LNA) and pre-filter designed for Beidou Global Positioning System/Global Navigation Satellite System (BDS/GPS/GNSS) receiver applications. The device provides high linearity, excellent gain, a high 1 dB input compression point (IP1dB), and a superior noise figure (NF).

The GPS pre-filter provides the low in-band insertion loss for excellent rejections of the cellular and WLAN frequency bands. The SKY65724-11 uses surface mount technology (SMT) in a Multi-Chip Module (MCM) package, which allows for a highly manufacturable and low-cost solution.

The LNA matching inductor is placed outside the module to enable performance optimization. The pin configuration and package are shown in Figure 1. A functional block diagram is shown in Figure 2. Signal pin assignments and functional pin descriptions are provided in Table 1.

Table 1. SKY65724-11 Signal Descriptions

Pin	Name	Description	Pin	Name	Description
1	VCC	Source voltage	5	GND	Ground
2	VEN	LNA enable	6	N/C	No connection
3	GND	Ground	7	N/C	No connection
4	RF_IN	RF input	8	RF_OUT	RF output

Technical Description

The VEN signal (pin 2) enables or disables the LNA. A logic high signal powers on the LNA and a logic low signal powers off the device.

Electrical and Mechanical Specifications

The absolute maximum ratings of the SKY65724-11 are provided in Table 2. The recommended operating conditions are specified in Table 3, and electrical specifications are provided in Tables 4 and 5.

Table 2. SKY65724-11 Absolute Maximum Ratings¹

Parameter	Symbol	Minimum	Maximum	Units
RF input power	Pin		0	dBm
Supply voltage	Vcc	0	4.5	V
Storage temperature	Tstg	-55	+150	°C
Junction temperature	Tj		+150	°C
Electrostatic discharge: Human Body Model (HBM), Class 1A	ESD		250	V

1. Exposure to maximum rating conditions for extended periods may reduce device reliability. There is no damage to device with only one parameter set at the limit and all other parameters set at or below their nominal value. Exceeding any of the limits listed here may result in permanent damage to the device.

ESD Handling: Industry-standard ESD handling precautions must be adhered to at all times to avoid damage to this device.

Table 3. SKY65724-11 Recommended Operating Conditions

Parameter	Symbol	Minimum	Typical	Maximum	Units
Frequency range	f	1559	1575	1606	MHz
Supply voltage (measured at terminals of Evaluation Board)	Vcc	1.62	1.8	3.6	V
LNA enable: Enable (high) Disable (low)	LNA _{ENABLE} LNA _{DISABLE}	Vcc - 0.3	0	Vcc 0.3	V V
Case operating temperature	Tc	-40		+85	°C

Table 4. SKY65724-11 Electrical Specifications¹
(VCC = 1.8 V, VEN = 1.8 V, f = 1575 MHz, TC= +25 °C, Unless Otherwise Noted)

Parameter	Symbol	Test Condition	Min	Typ	Max	Units
Small signal gain	S21	P _{IN} = -30 dBm		15.5		dB
Noise figure	NF			1.8 ²		dB
In-band third order input intercept point	IIP3	f = 1575 MHz @ P _N = -30 dBm f = 1576 MHz @ P _{IN} = -30 dBm		-11		dBm
1 dB input compression point	IP1dB			-20		dBm
Reverse isolation	S12	P _{IN} = -30 dBm		30		dB
Input return loss	S11	P _{IN} = -30 dBm		8		dB
Output return loss	S22	P _{IN} = -30 dBm		9		dB
Supply current	I _{CC}	No RF		3.8		mA
Shutdown current	I _{LEAK}	No RF, V _{EN} = 0 V		0.1		mA
Out-of-band rejection:	OOB	P _{IN} = 0 dBm: @ 777 to 798 MHz @ 806 to 928 MHz @ 1710 to 1980 MHz @ 2400 to 2500 MHz @ 5160 to 5560 MHz		55 55 45 45 45		dBc dBc dBc dBc dBc
Band 13 2nd harmonic	B13 _{2f_o}	P _{IN} = +15 dBm @ 787.76 MHz measured @ 1575.52 MHz output referred		-43		dBm
LNA turn-on time	t _{ON}	P _{IN} = -30 dBm, V _{CC} = 1.8 V, 50% of V _{ENABLE} to 90% final RF power		1		μs
LNA turn-off time	t _{OFF}	P _{IN} = -30 dBm, V _{CC} = 1.8 V, 50% of V _{ENABLE} to 10% final RF power		0.2		μs

1. Performance is guaranteed only under the conditions listed in this Table and is not guaranteed over the full operating or storage temperature ranges. Operation at elevated temperatures may reduce reliability of the device.
2. 0.1 dB has been de-embedded for input connector and trace loss.

Table 5. SKY65724-11 Electrical Specifications¹

Parameter	Symbol	Test Condition	Min	Typ	Max	Units
Small signal gain	S21		13	16		dB
Noise figure	NF		1	1.8 ²	3	dB
In-band third order input intercept point	IIP3	f = 1575 MHz @ PN = -30 dBm f = 1576 MHz @ PIN = -30 dBm		-10.5		dBm
1 dB input compression point	IP1dB	@ 1575 MHz		-19		dBm
Reverse isolation	S12	PIN = -30 dBm		29		dB
Input return loss	S11	PIN = -30 dBm		7.5		dB
Output return loss	S22	PIN = -30 dBm		9		dB
Supply current	ICC	No RF	3	4.2	6	mA
Shutdown current	I _{LEAK}	No RF, VEN = 0 V		0.1	1.0	mA
Out-of-band rejection	OOB	PIN = 0 dBm (in-band referred): @ 777 to 798 MHz @ 806 to 928 MHz @ 1710 to 1980 MHz @ 2400 to 2500 MHz @ 5160 to 5560 MHz		55 55 45 45 45		dBc dBc dBc dBc dBc
Band 13 2nd harmonic	B13 _{2fo}	PIN = +15 dBm @ 787.76 MHz measured @ 1575.52 MHz output referred		-45		dBm
LNA turn-on time	t _{ON}	PIN = -30 dBm, VCC = 2.8 V, 50% of VENABLE to 90% final RF power		1	2	μs
LNA turn-off time	t _{OFF}	PIN = -30 dBm, VCC = 2.8 V, 50% of VENABLE to 10% final RF power		0.2	1	μs

1. Performance is guaranteed only under the conditions listed in this Table and is not guaranteed over the full operating or storage temperature ranges. Operation at elevated temperatures may reduce reliability of the device.
2. 0.1 dB has been de-embedded for input connector and trace loss.

Evaluation Board Description

The SKY65724-11 Evaluation Board is used to test the performance of the SKY65724-11 LNA. An application schematic diagram is shown in Figure 3. An assembly drawing for the Evaluation Board is shown in Figure 4. Table 6 provides the Bill of Materials (BOM) list for Evaluation Board, layer details are shown in Figure 5, and the layer physical characteristics are shown in Figure 6.

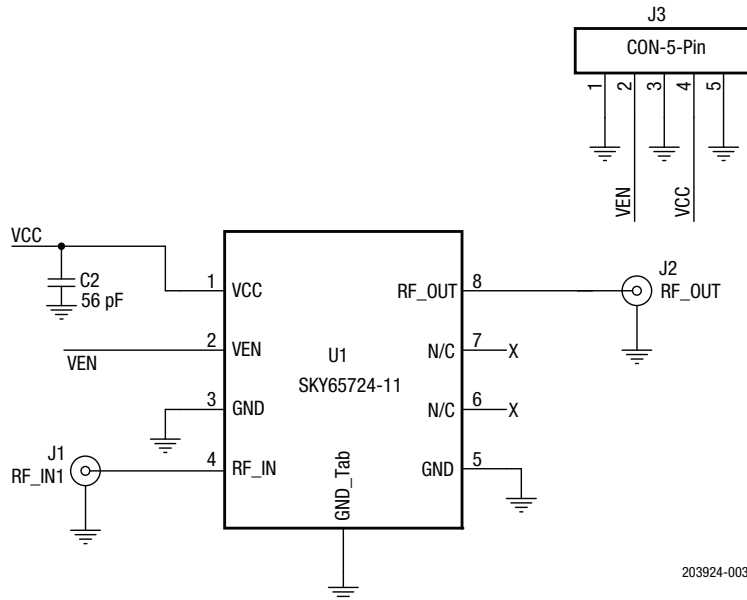

Figure 3. SKY65724-11 Application Schematic

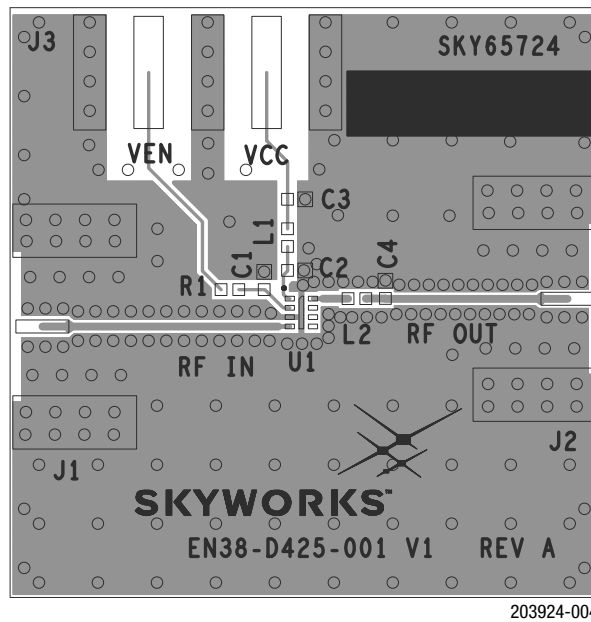
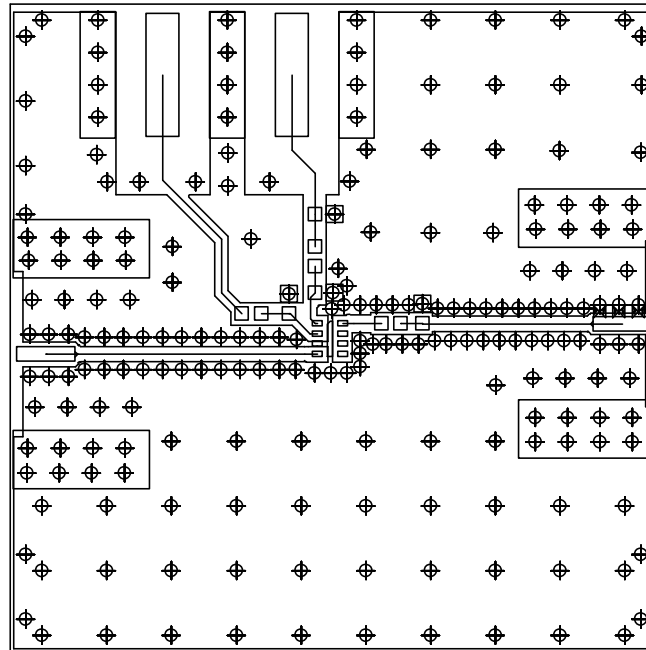

Figure 4. SKY65724-11 Evaluation Board Assembly Diagram

Table 6. SKY65724-11 Evaluation Board Bill of Materials

Component	Size	Value	Manufacturer	Mfr Part Number
C2	0402	56 pF	MuRata	GRM0222C1H560JA02
C1, C3, C4	DNI			
R1, L1, L2	0402	0 Ω	Panasonic ECG	ERJ2GE0R00X



203924-005

Figure 5. Evaluation Board Layer Details

Cross Section	Name	Thickness	Materials
	TOP SOLDERMASK		
	L1	(0.0007)	1/2 OZ. COPPER
	DIELECTRIC	0.008	ROGERS 4003
	L2	(0.0014)	1 OZ. COPPER
	DIELECTRIC	ADJUST TO MEET REQUIRED THICKNESS FR4	
	L3	(0.0007)	1/2 OZ. COPPER
	BOTTOM SOLDERMASK		

203924-006

Figure 6. Layer Detail Physical Characteristics

Package Dimensions

The PCB layout footprint for the SKY65724-11 is provided in Figure 7. Typical part marking is shown in Figure 8. Package dimensions are shown in Figure 9, and tape and reel dimensions are provided in Figure 10.

Package and Handling Information

Since the device package is sensitive to moisture absorption, it is baked and vacuum packed before shipping. Instructions on the shipping container label regarding exposure to moisture after the container seal is broken must be followed. Otherwise, problems related to moisture absorption may occur when the part is subjected to high temperature during solder assembly.

The SKY65724-11 is rated to Moisture Sensitivity Level 3 (MSL3) at 260 °C. It can be used for lead or lead-free soldering. For additional information, refer to the Skyworks Application Note, Solder Reflow Information, document number 200164.

Care must be taken when attaching this product, whether it is done manually or in a production solder reflow environment. Production quantities of this product are shipped in a standard tape and reel format.

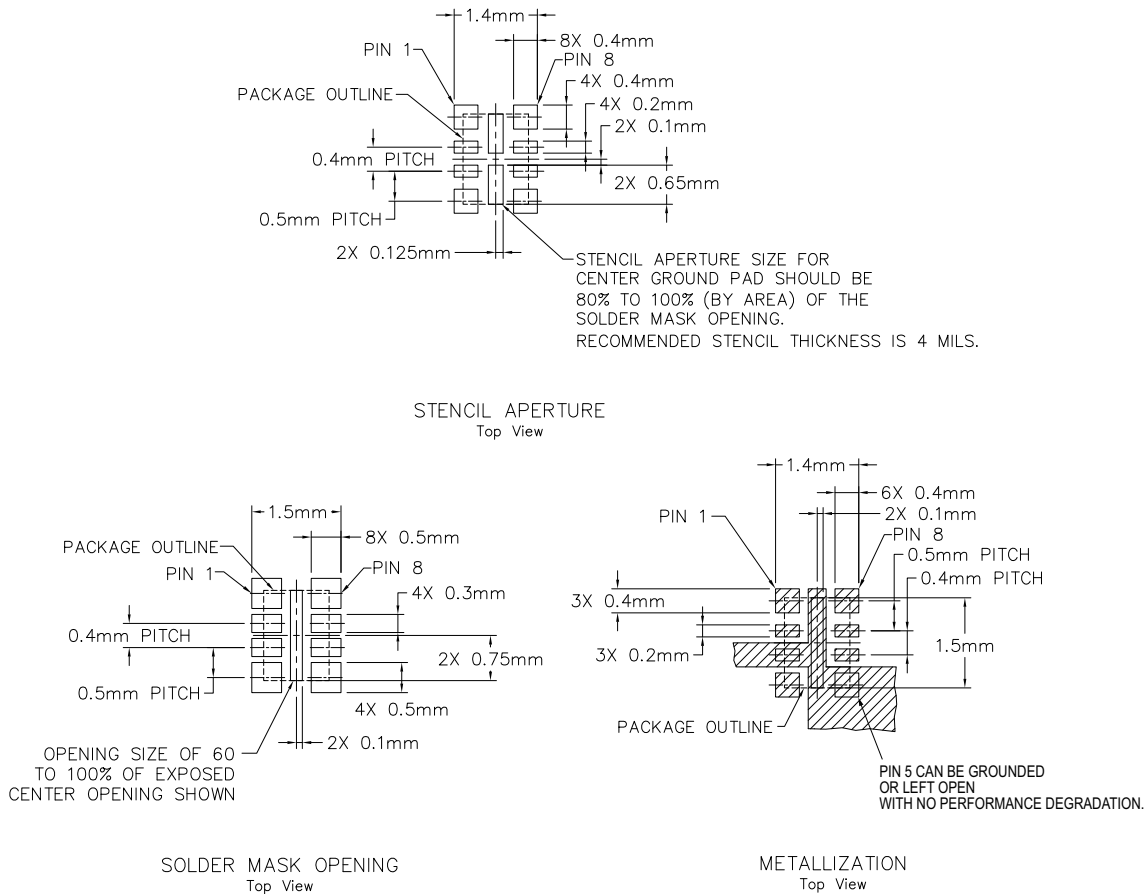

NOTE: THERMAL VIAS SHOULD BE RESIN FILLED AND CAPPED IN ACCORDANCE WITH IPC-4761 TYPE VII VIAS. 30-35UM Cu THICKNESS IS RECOMMENDED.

203924-007

Figure 7. SKY65724-11 PCB Layout Footprint

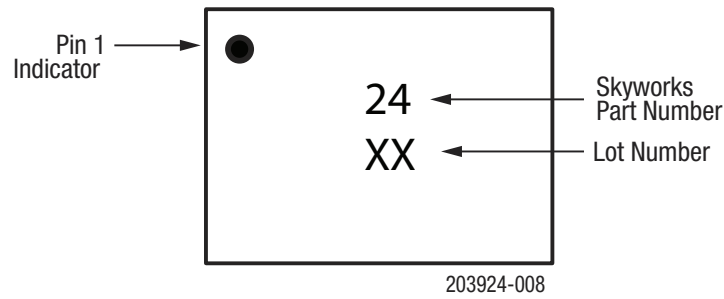
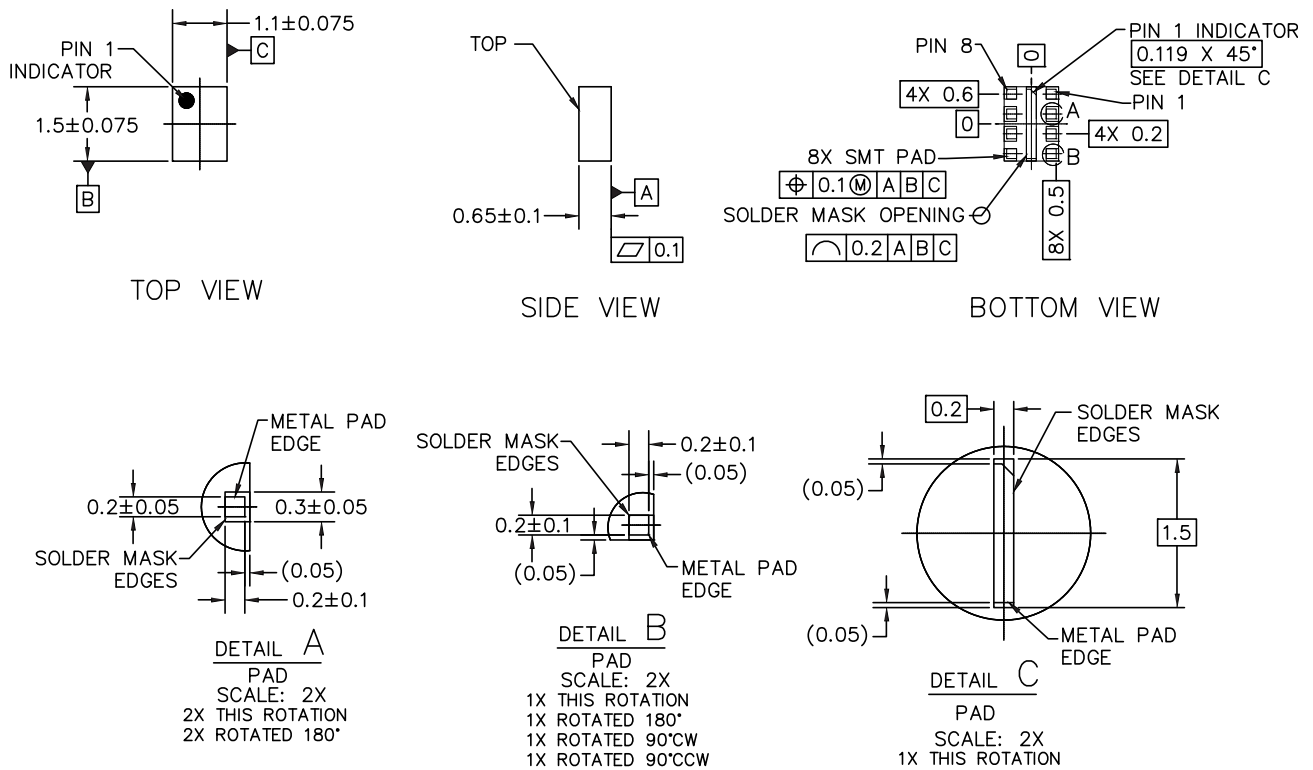

Figure 8. SKY65724-11 Typical Part Marking (Top View)



NOTES: UNLESS OTHERWISE SPECIFIED.
 1. DIMENSIONING AND TOLERANCING IN ACCORDANCE WITH ASME Y14.5M-1994.
 2. DIMENSIONS ARE IN MILLIMETERS

203924-009

Figure 9. SKY65724-11 Package Dimensions

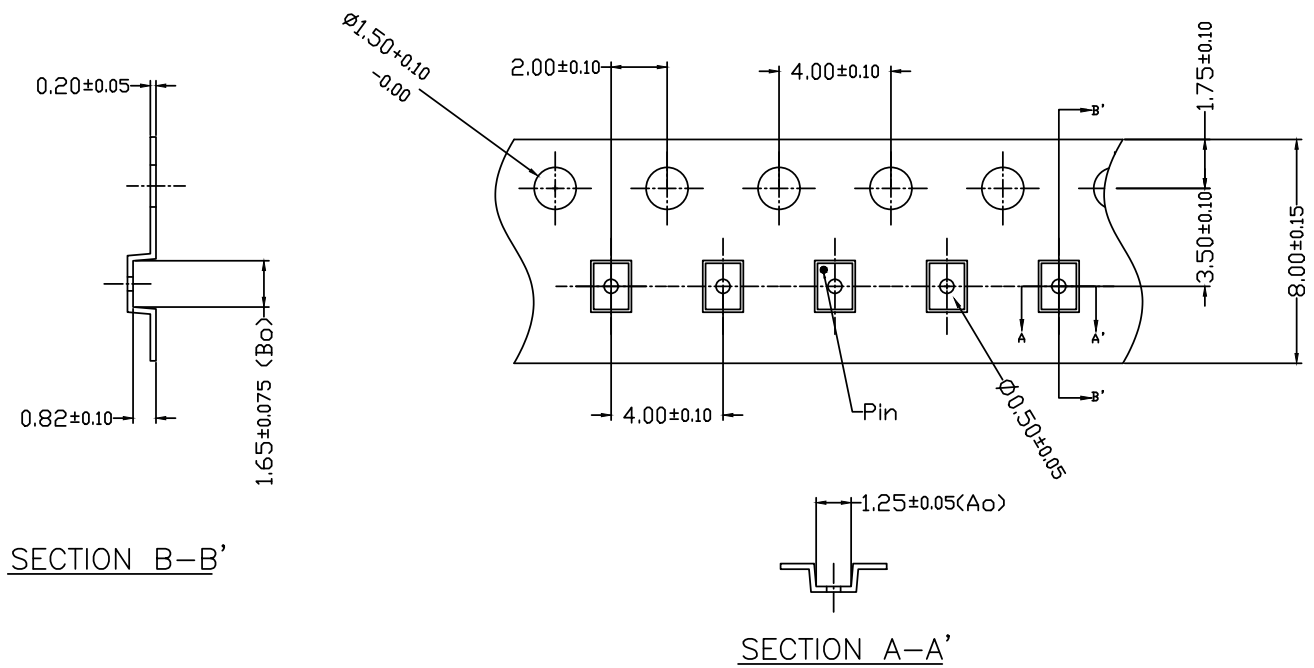

10 SPROCKET HOLE PITCH CUMULATIVE TOLERANCE : $\pm 0.20\text{mm}$
 Ao & Bo MEASURED ON PLANE 0.30mm ABOVE THE BOTTOM OF THE POCKET.
 ALL DIMENSIONS ARE IN MILLIMETERS.

203924-010

Figure 10. SKY65724-11 Tape and Reel Dimensions

Ordering Information

Part Number	Part Description	Evaluation Board Part Number
SKY65724-11	Low-Noise Amplifier Front-End Module with Pre-Filter for BDS/GPS/GNSS Applications	SKY65724-11EK1

Copyright © 2016-2019, 2023, Skyworks Solutions, Inc. All Rights Reserved.

Information in this document is provided in connection with Skyworks Solutions, Inc. ("Skyworks") products or services. These materials, including the information contained herein, are provided by Skyworks as a service to its customers and may be used for informational purposes only by the customer. Skyworks assumes no responsibility for errors or omissions in these materials or the information contained herein. Skyworks may change its documentation, products, services, specifications or product descriptions at any time, without notice. Skyworks makes no commitment to update the materials or information and shall have no responsibility whatsoever for conflicts, incompatibilities, or other difficulties arising from any future changes.

No license, whether express, implied, by estoppel or otherwise, is granted to any intellectual property rights by this document. Skyworks assumes no liability for any materials, products or information provided hereunder, including the sale, distribution, reproduction or use of Skyworks products, information or materials, except as may be provided in Skyworks' Terms and Conditions of Sale.

THE MATERIALS, PRODUCTS AND INFORMATION ARE PROVIDED "AS IS" WITHOUT WARRANTY OF ANY KIND, WHETHER EXPRESS, IMPLIED, STATUTORY, OR OTHERWISE, INCLUDING FITNESS FOR A PARTICULAR PURPOSE OR USE, MERCHANTABILITY, PERFORMANCE, QUALITY OR NON-INFRINGEMENT OF ANY INTELLECTUAL PROPERTY RIGHT; ALL SUCH WARRANTIES ARE HEREBY EXPRESSLY DISCLAIMED. SKYWORKS DOES NOT WARRANT THE ACCURACY OR COMPLETENESS OF THE INFORMATION, TEXT, GRAPHICS OR OTHER ITEMS CONTAINED WITHIN THESE MATERIALS. SKYWORKS SHALL NOT BE LIABLE FOR ANY DAMAGES, INCLUDING BUT NOT LIMITED TO ANY SPECIAL, INDIRECT, INCIDENTAL, STATUTORY, OR CONSEQUENTIAL DAMAGES, INCLUDING WITHOUT LIMITATION, LOST REVENUES OR LOST PROFITS THAT MAY RESULT FROM THE USE OF THE MATERIALS OR INFORMATION, WHETHER OR NOT THE RECIPIENT OF MATERIALS HAS BEEN ADVISED OF THE POSSIBILITY OF SUCH DAMAGE.

Skyworks products are not intended for use in medical, lifesaving or life-sustaining applications, or other equipment in which the failure of the Skyworks products could lead to personal injury, death, physical or environmental damage. Skyworks customers using or selling Skyworks products for use in such applications do so at their own risk and agree to fully indemnify Skyworks for any damages resulting from such improper use or sale.

Customers are responsible for their products and applications using Skyworks products, which may deviate from published specifications as a result of design defects, errors, or operation of products outside of published parameters or design specifications. Customers should include design and operating safeguards to minimize these and other risks. Skyworks assumes no liability for applications assistance, customer product design, or damage to any equipment resulting from the use of Skyworks products outside of Skyworks' published specifications or parameters.

Skyworks, the Skyworks symbol, Sky5®, SkyOne®, SkyBlue™, Skyworks Green™, ClockBuilder®, DSPLL®, ISOModem®, ProSLIC®, SiPHY®, and RFelC® are trademarks or registered trademarks of Skyworks Solutions, Inc. or its subsidiaries in the United States and other countries. Third-party brands and names are for identification purposes only and are the property of their respective owners. Additional information, including relevant terms and conditions, posted at www.skyworksin.com, are incorporated by reference.